

SEG'SHOW 4 - 20X10

SEG'SHOW MODULAR EXHIBITS

PRODUCT CODE: SEGSHOW4-20x10G



On frame On graphic



FRONT



BACK

PRODUCT DESCRIPTION

Seg>Show Modular Exhibits Modular 4 is a three-dimensional 20' x 10' pre-designed exhibit booth. Stylish and lively, Modco Modular Exhibits Modular 4 is built using tool-free perforated modular aluminum frames. Multiple size frames connect using simple toolless pin connectors. Use shelves to showcase your products. Customize double-sided stretch fabric SEG graphics for the entire exhibit.

DISPLAY DIMENSIONS	234.375"W x 97.9"H x 117.5"D		
GRAPHIC SIZES	PANEL	SIZE	QTY
	A	196.375"W x 96.25"H	1
	B	235.375"W x 96.25"H	1
	C	35.25"W x 94.375"H	1
	D	20.5"W x 96.25"H	2
	E	40.125"W x 96.25"H	2
	F	40.125"W x 109.125"	1
	G	40.125"W x 109.125"	1
	H	39.125"W x 97.75"	2
TOTAL PRINTS			11

GRAPHIC MATERIAL

Stretch Fabric w/Integrated Block Out

GRAPHIC FINISHING

Silicone beading is sewn around the perimeter of the fabric graphic. Silicone beading is hidden from view once installed.

DISPLAY CONSTRUCTION

Aluminum frame and components

SHIPPING WEIGHTS & DIMENSIONS (FREIGHT ONLY)

Shipping Weight	1107 lbs (frame & graphics in crate)
Shipping Dimensions	103"L x 44"W x 58"H (in crate)

GRAPHIC TURN AROUND TIME

5 business days after proof approval

AVAILABILITY	CA only
--------------	---------

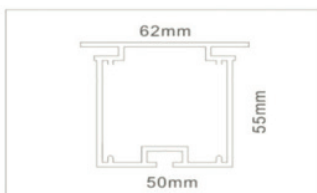
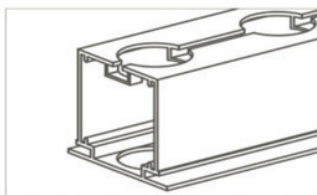

FRAME ONLY

PARTS LIST

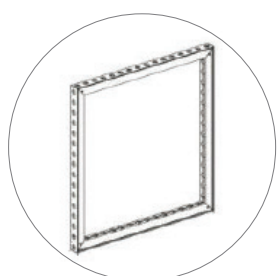

(qty 9)
MOD-FRM-992x2418

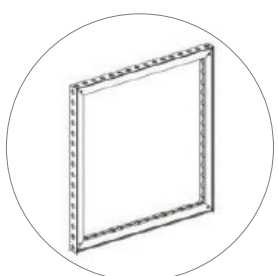

(qty 1)
MOD-FRM-310x1984

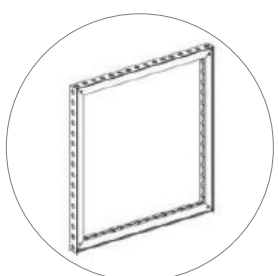

(qty 1)
MOD-FRM-992x1984



(qty 1)
MOD-CRVFRM-774x992

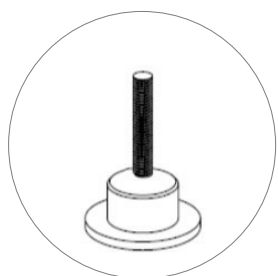

(qty 4)
MOD-PCWP-B



(qty 1)
MOD-DSWL-992x2418



(qty 4)
MOD-SN28mm

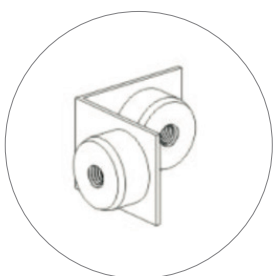

(qty 16)
MOD-90D-CON

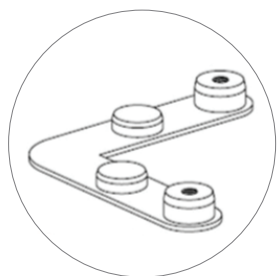

(qty 6)
MOD-SM90D-CON

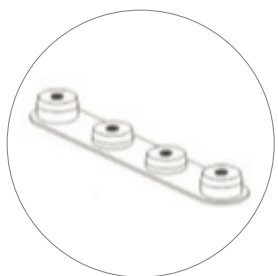

(qty 2)
MOD-CRV-180DCL

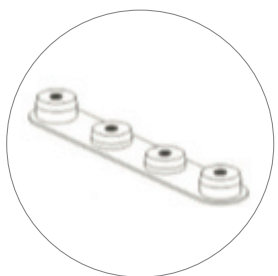

(qty 2)
MOD-CRV-180DCR

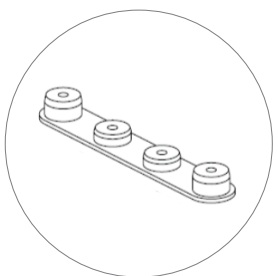

(qty 8)
MOD-180D-CON



(qty 1)
MOD-CP-3100

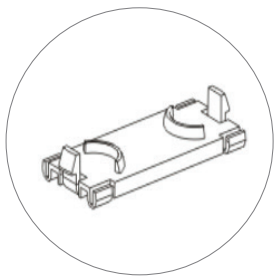

(qty 23)
MOD-CC

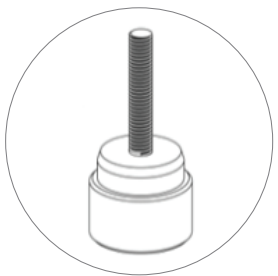

(qty 80)
MOD-PC



(qty 2)
MOD-CP-774

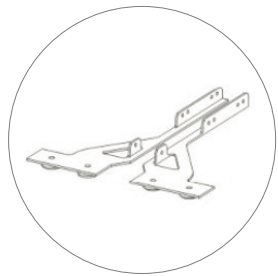

(qty 4)
MOD-SHELF-KIT-INS

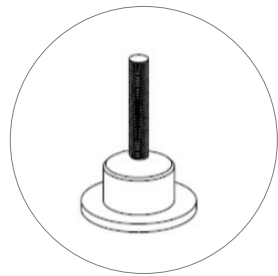

(qty 4)
MOD-PC-DOOR

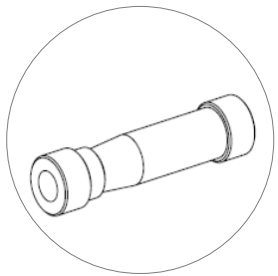

(qty 10)
MOD-CLA-CON

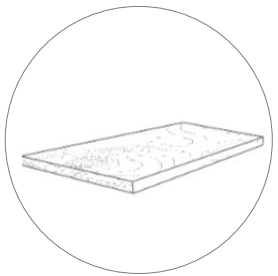

(qty 4)
MOD-PNL

SET UP INSTRUCTIONS

MODCO-4

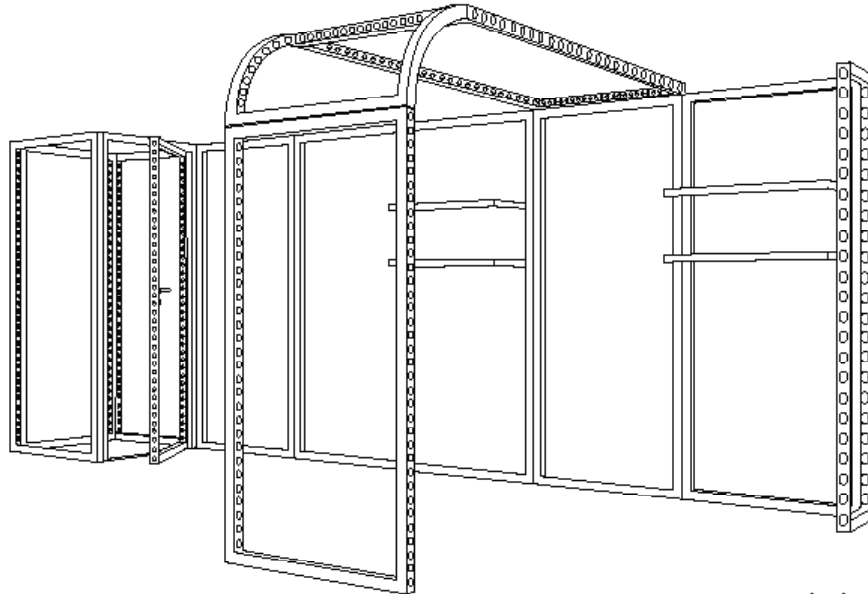

Instructions

Parts / Frames

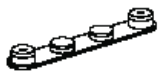

180° Connector
MOD-180D-COM
Qty:5

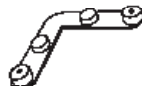

Small 90° Connector
MOD-SM90D-COM
Qty:5



Pin Connector
MOD-PC
Qty:64



Door Pin Connector
MOD-PCDOOR
Qty:4



Clip Connector
MOD-CC
Qty:21



180° Curved Connector
MOD-CRF-180DCL
Qty:2
MOD-CRF-180DCH
Qty:2

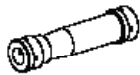

Clamp Connector
MOD-CLA-COM
Qty:10



90° Connector
MOD-90D-COM
Qty:15



1/4 Curved Cover Profile
MOD-CP-774
Qty:2



1/4" / 3/8" Cover Profile
MOD-CP-5100
Qty:2 - 58" / Qty:2 - 78"



90° Cover Profile
MOD-CP-5100
Qty:4



Shelf Kit (part/kit)
MOD-SHELF-KIT-INS
Qty:4 (pair)



90° Door
MOD-DSWL-992x2418
Qty:1



902 x 1984
MOD-FRM-992x1984
Qty:1



992 x 2418
MOD-FRM-992x2418
Qty:3



992 x 2418
MOD-FRM-992x2418
Qty:1

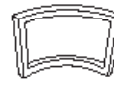

992 x 992
MOD-CFR-FRM-774x992
Qty:1



Cover Shelf
MOD-PVL
Qty:4

Connections I

A

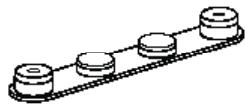

MOD-180D-CON / MOD-PC

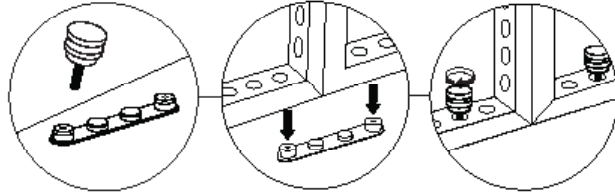

B



MOD-CLA-CON

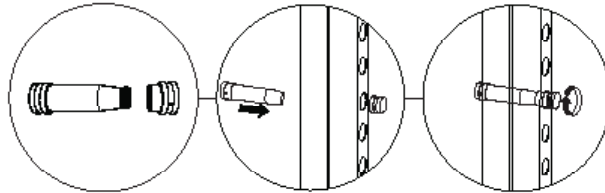

C

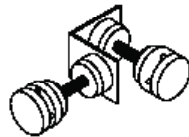

MOD-90D-CON + MOD-PC

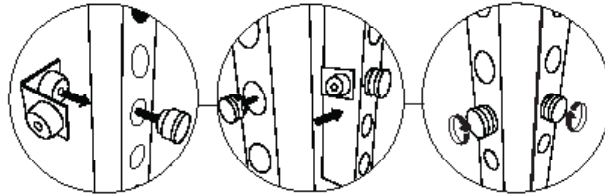

Connections II

D

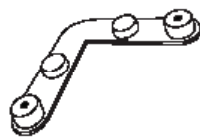

MOD-SM90D-CON / MOD-PC

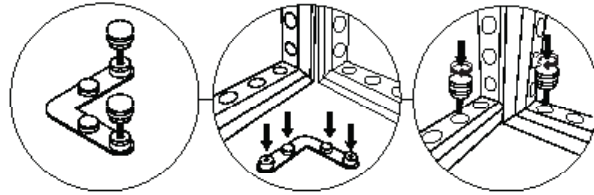

E

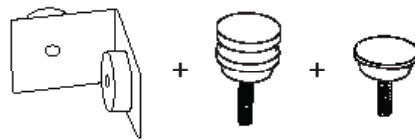

MOD-90D-CON / MOD-PC / MOD-PCDOOR

*Same as (C) but MOD-PCDOOR will be inside of door jam

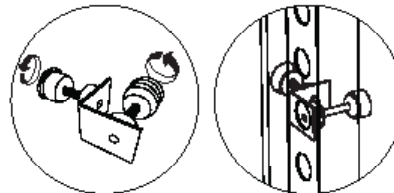

F

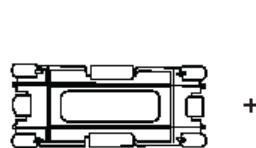

MOD-CC / MOD-CP-3100 / MOD-CP-774

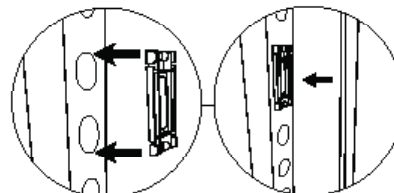

Connections III

G

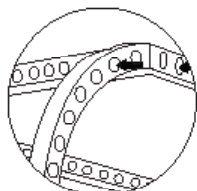
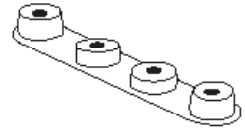

OUTSIDE

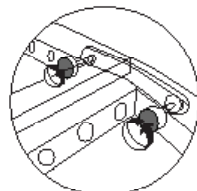

INSIDE

H

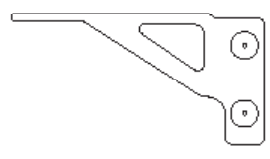

MOD-SHELF-KIT-INS

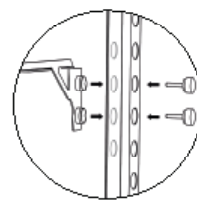

INSIDE OF FRAME

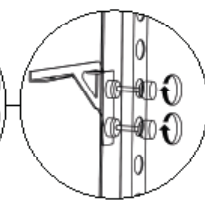

1

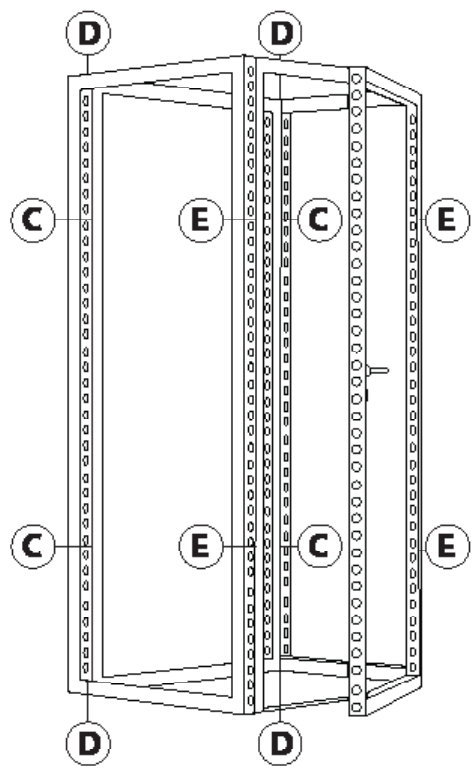

SEG'SHOW 4 - 20X10

SEG'SHOW MODULAR EXHIBITS
PRODUCT CODE: SEGSHOW4-20X10G



On frame On graphic

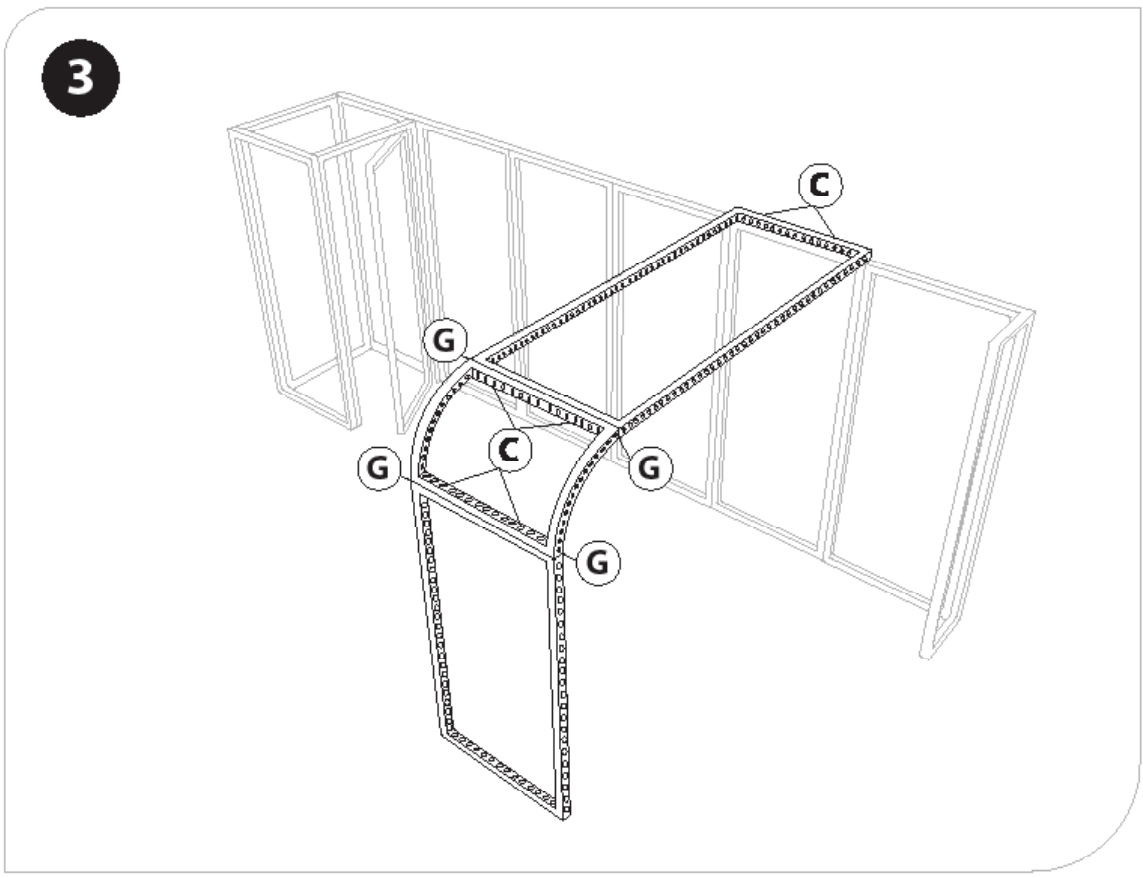
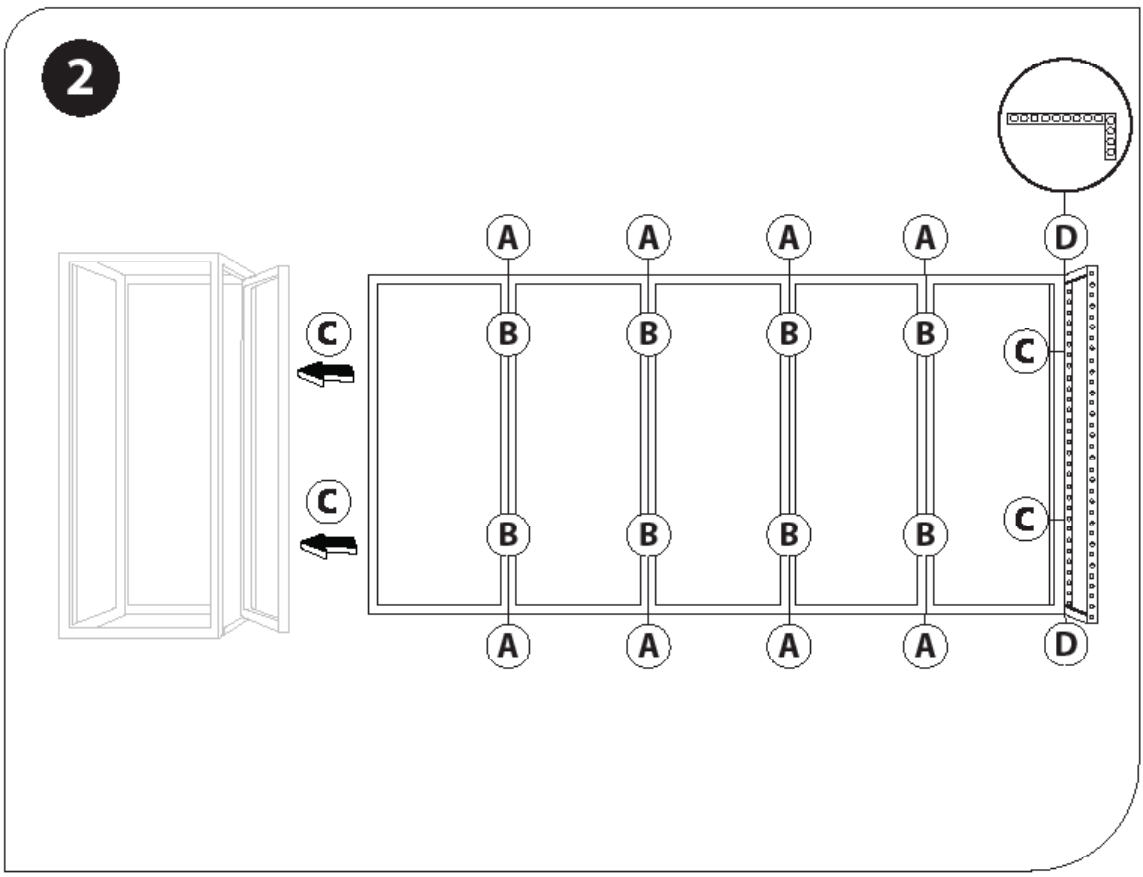

4

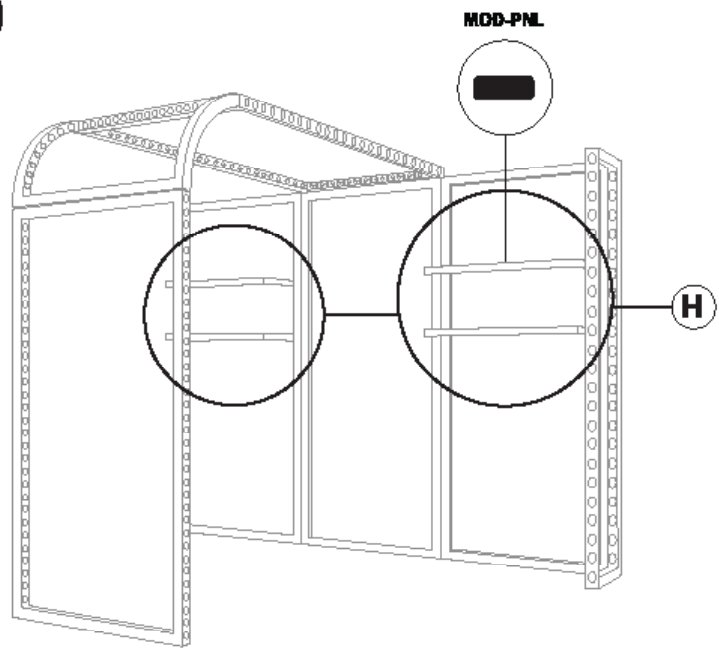

Slide panels onto shelf brackets. NO DRILLING REQUIRED.

Cover Profiles

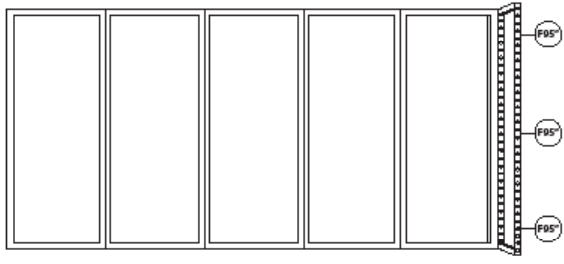
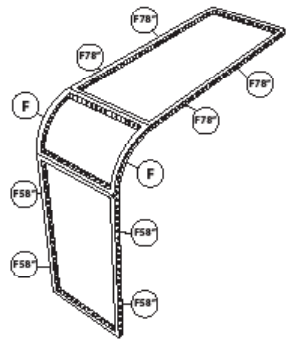
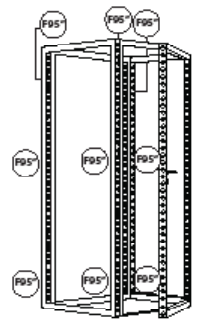

Snap in clip connectors at each designated point and then reference the measurement and install the cover profile.
***Overhead view - clip connectors/cover profiles to back side of configuration.**

SEG'SHOW 4 - 20X10

SEG'SHOW MODULAR EXHIBITS
PRODUCT CODE: SEGSHOW4-20x10G



On frame On graphic

Graphic Install



Place graphic over the front of the frame.

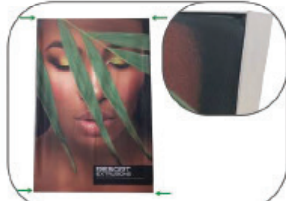

Begin inserting SEG beading at each corner.

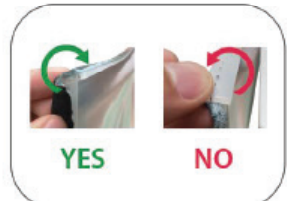

Insert the silicone beading with the fabric folded over. The silicone beading should not be exposed.

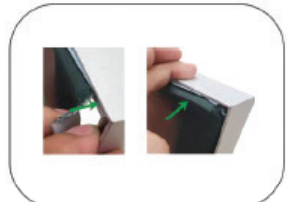

Using your fingers, push both fabric and silicone beading completely into the extrusions channel.

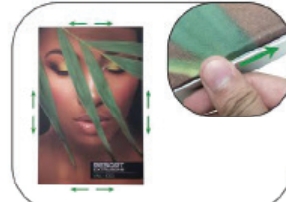

Continue to push in the remaining silicone beading on each side.

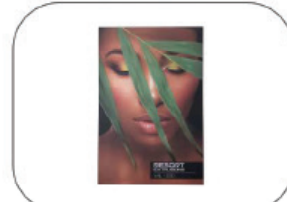

Check the perimeter of the frame for any excess beading that hasn't been pushed in. Graphic should be taut.