

SEG'SHOW-3-20x10

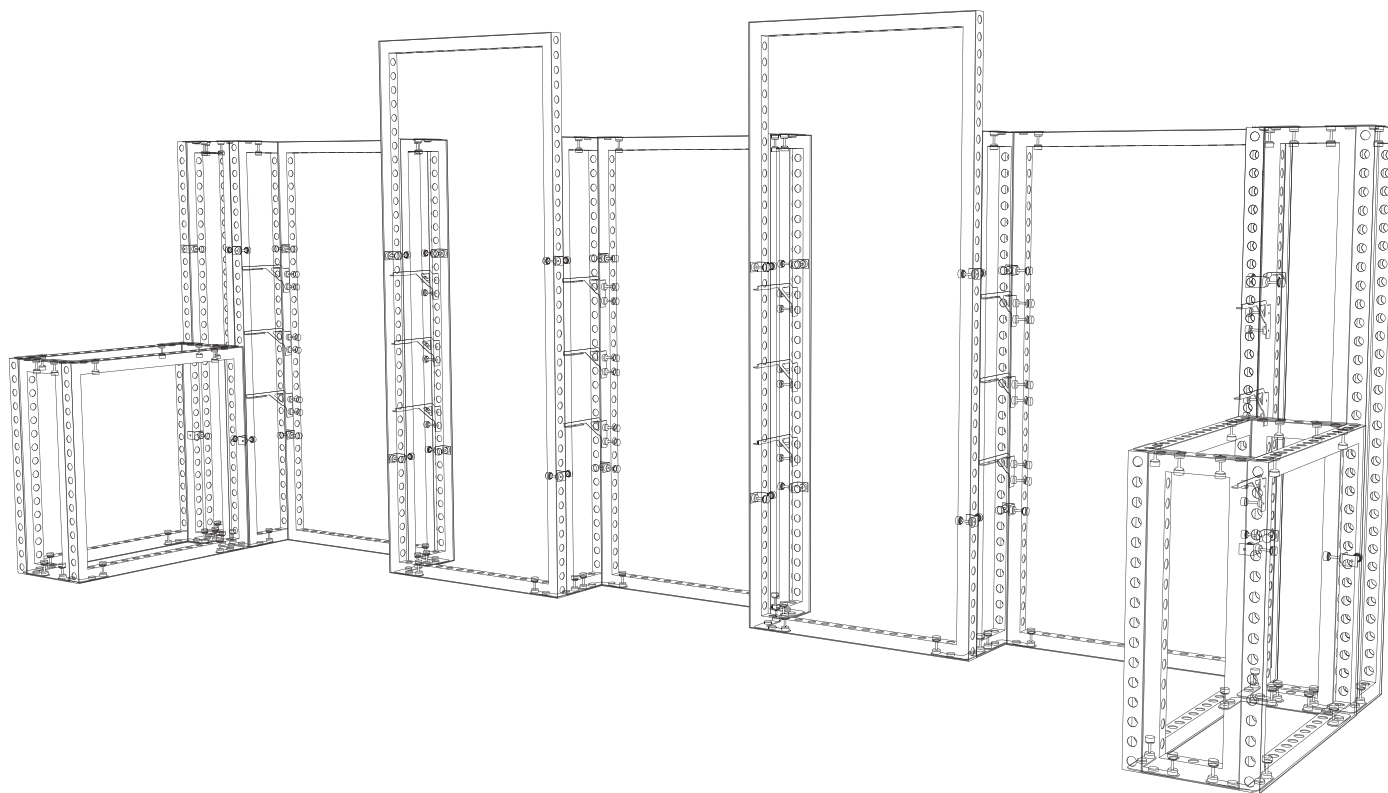

Instructions

Parts / Frames

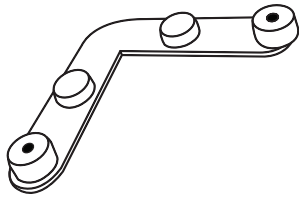

Small 90° Connector
MOD-SM90D-CON
Qty.28

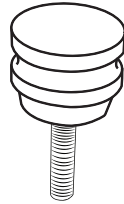

Pin Connector
MOD-PC
Qty.154

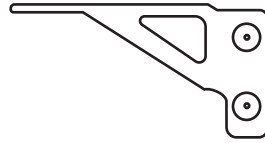

Shelf Kit (left/right)
MOD-SHELF-KIT
Qty.9 (pair)

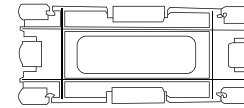

Clip Connector
MOD-CC
Qty.40

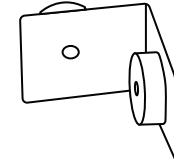

90° Connector
MOD-90D-CON
Qty.24



17" Cover Profile
MOD-CP-3100
Qty.4 - 17"

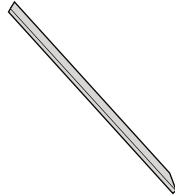

39" Cover Profile
MOD-CP-3100
Qty.8 - 39"



78" Cover Profile
MOD-CP-3100
Qty.16 - 78"

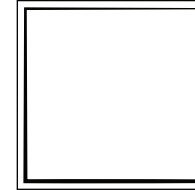

992 x 992
MOD-FRM-992x992
Qty.4



310 x 992
MOD-FRM-312x992
Qty.4



310 x 1984
MOD-FRM-312x1984
Qty.10

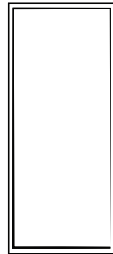

992 x 1984
MOD-FRM-992x1984
Qty.3



992 x 2418
MOD-FRM-992x2418
Qty.2



Counter Shelves
MOD-PNL
Qty.9

Connections

C

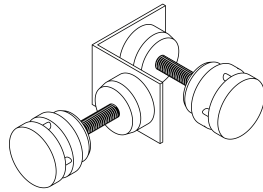

MOD-90D-CON + MOD-PC
Pin Connector heads remain on the inside of frames.

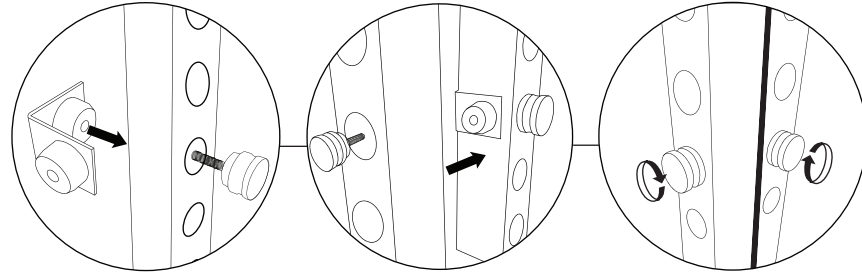

D

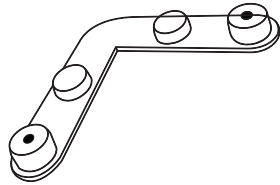

MOD-SM90D-CON / MOD-PC

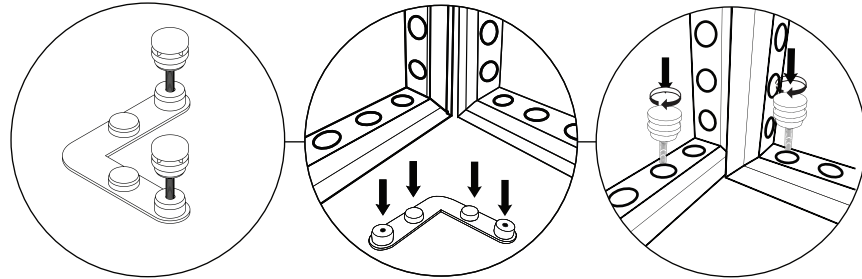

E

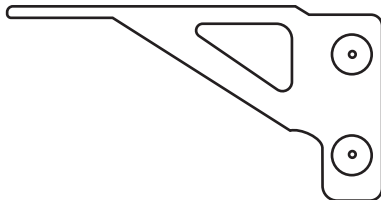

MOD-SHELF-KIT

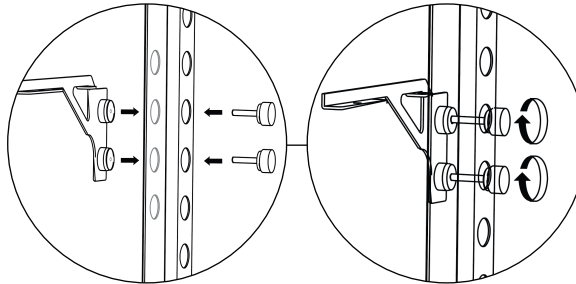

F

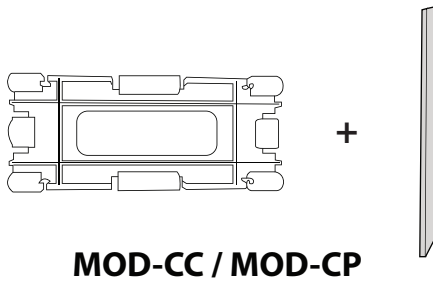

MOD-CC / MOD-CP

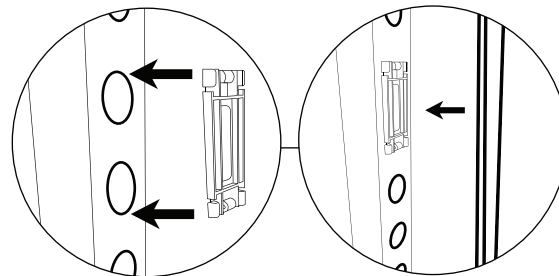

1

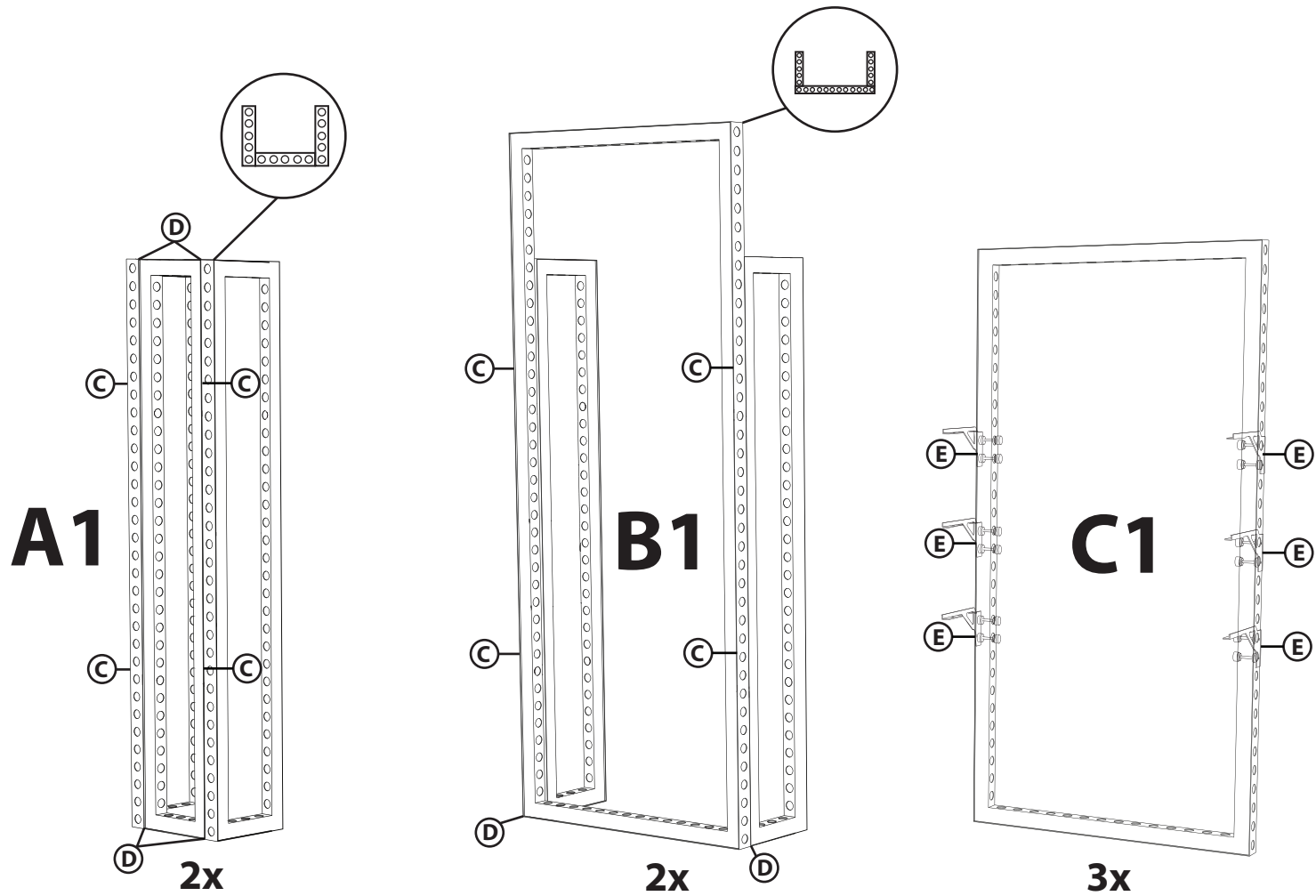

Qty.10 - MOD-FRM-312x1984
Qty.2 - MOD-FRM-992x2418
Qty.3 - MOD-FRM-992x1984
Qty.12 - MOD-SM90D-CON
Qty.16 - MOD-90D-CON
Qty.9 pair - MOD-SHELF-KIT
Qty.84 - MOD-PC

A1 / B1 sections need graphics to be installed before connecting to C1.

2

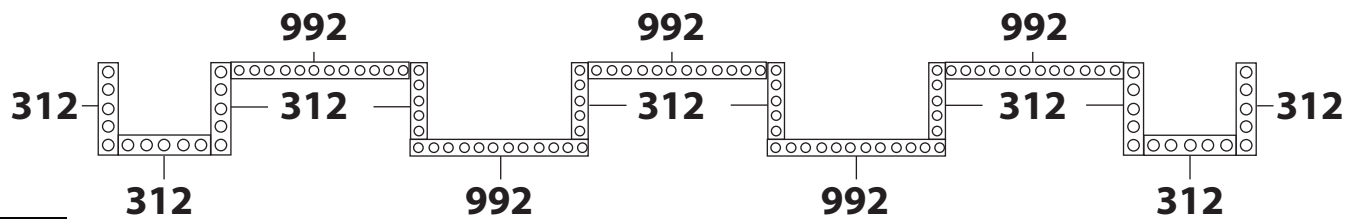
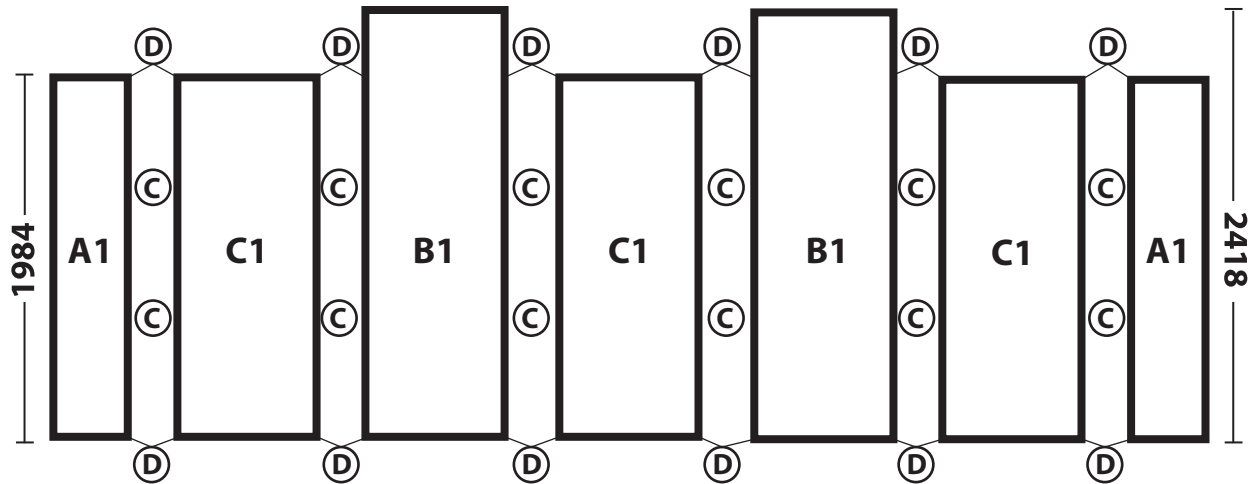
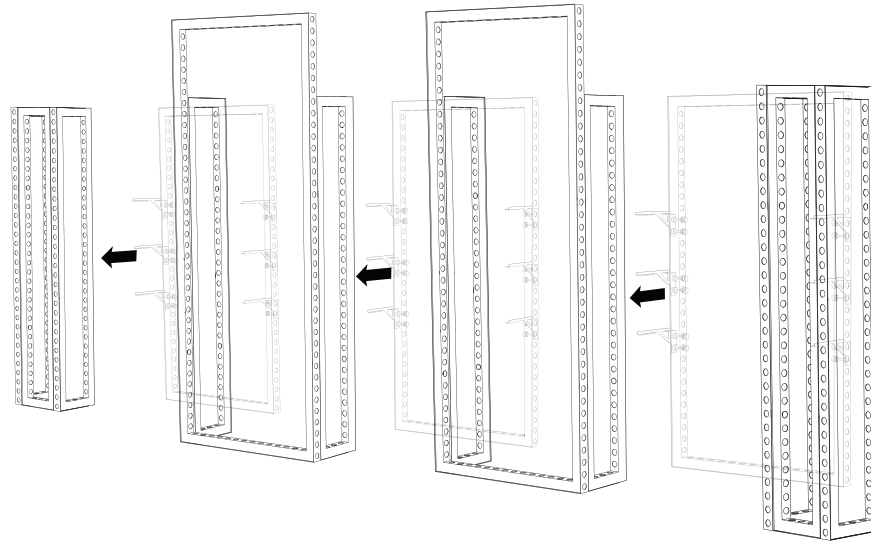

Qty.12 - MOD-SM90D-CON
Qty.12 - MOD-90D-CON
Qty.48 - MOD-PC

3

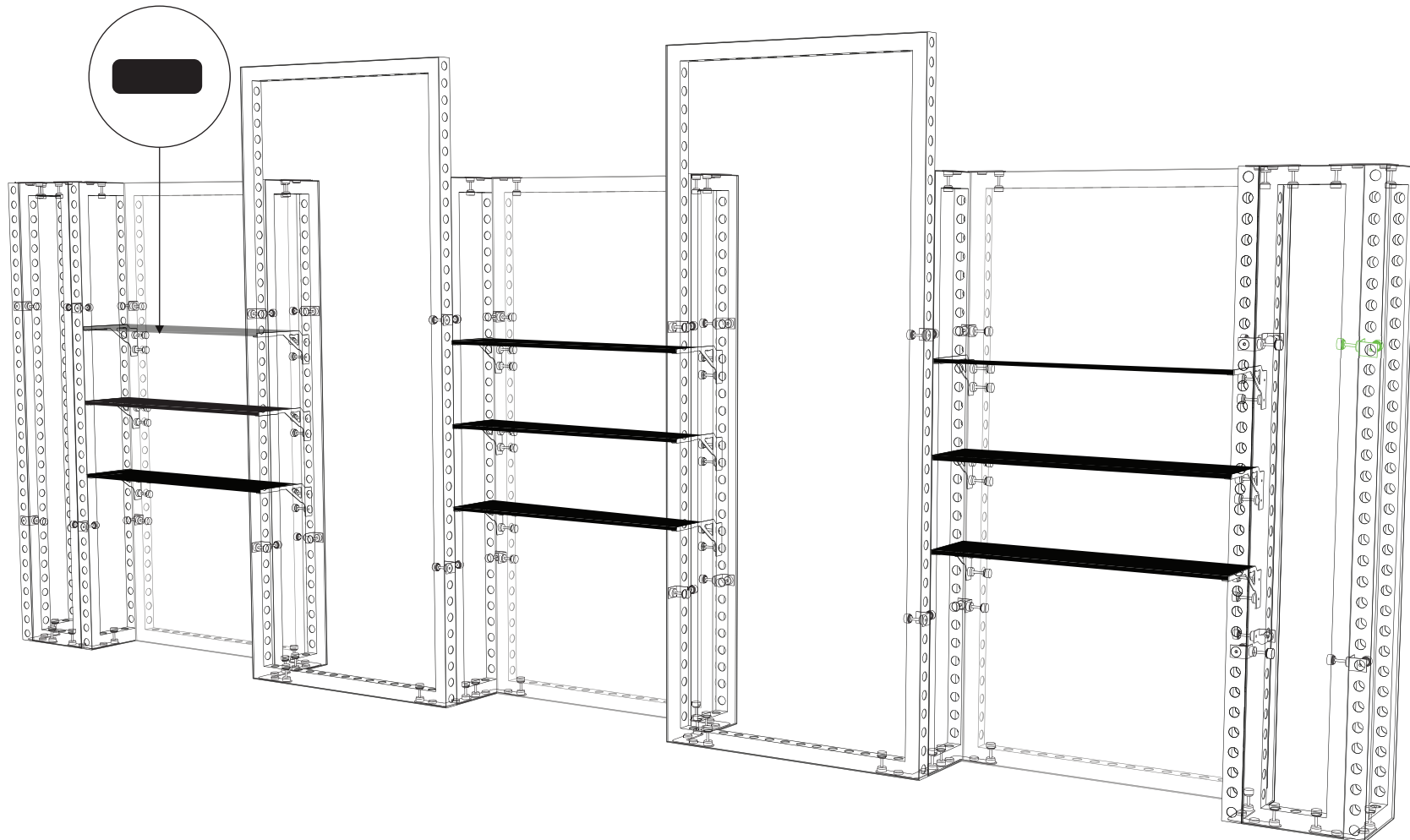

Qty.9 - MOD-PNL

Slide panels onto shelf brackets. NO DRILLING REQUIRED.

4

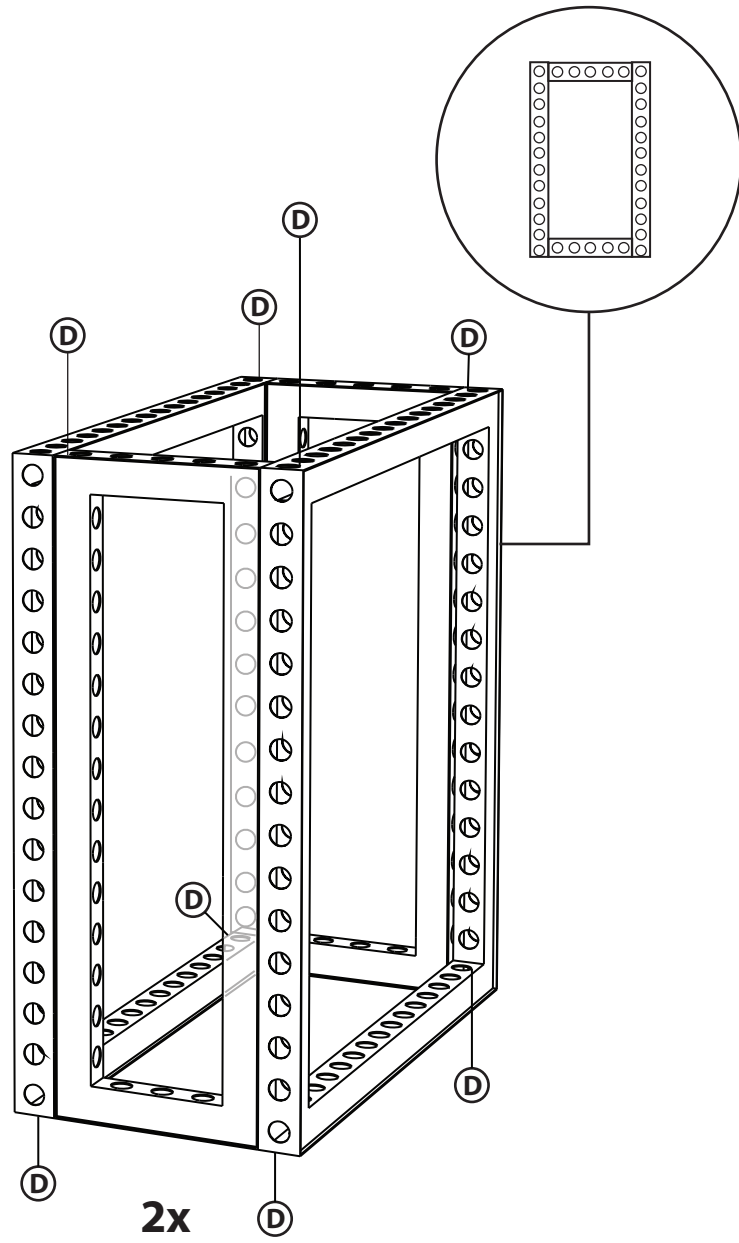

2x

- Qty.4 - MOD-FRM-312x992
- Qty.4 - MOD-FRM-992x992
- Qty.16 - MOD-SM90D-CON
- Qty.32 - MOD-PC

5

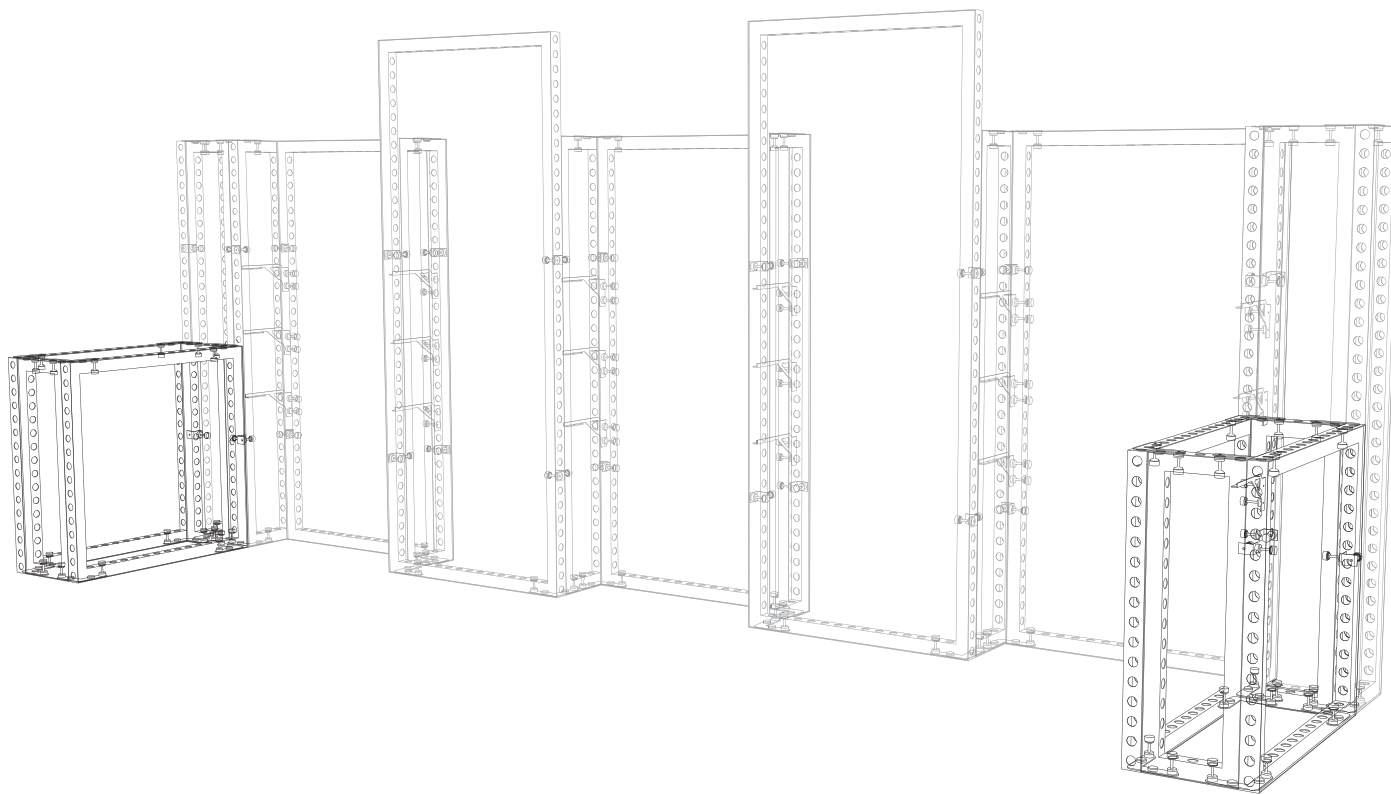

Counters are independent / DOES NOT ATTACH TO BACKWALL BOOTH.

Cover Profiles

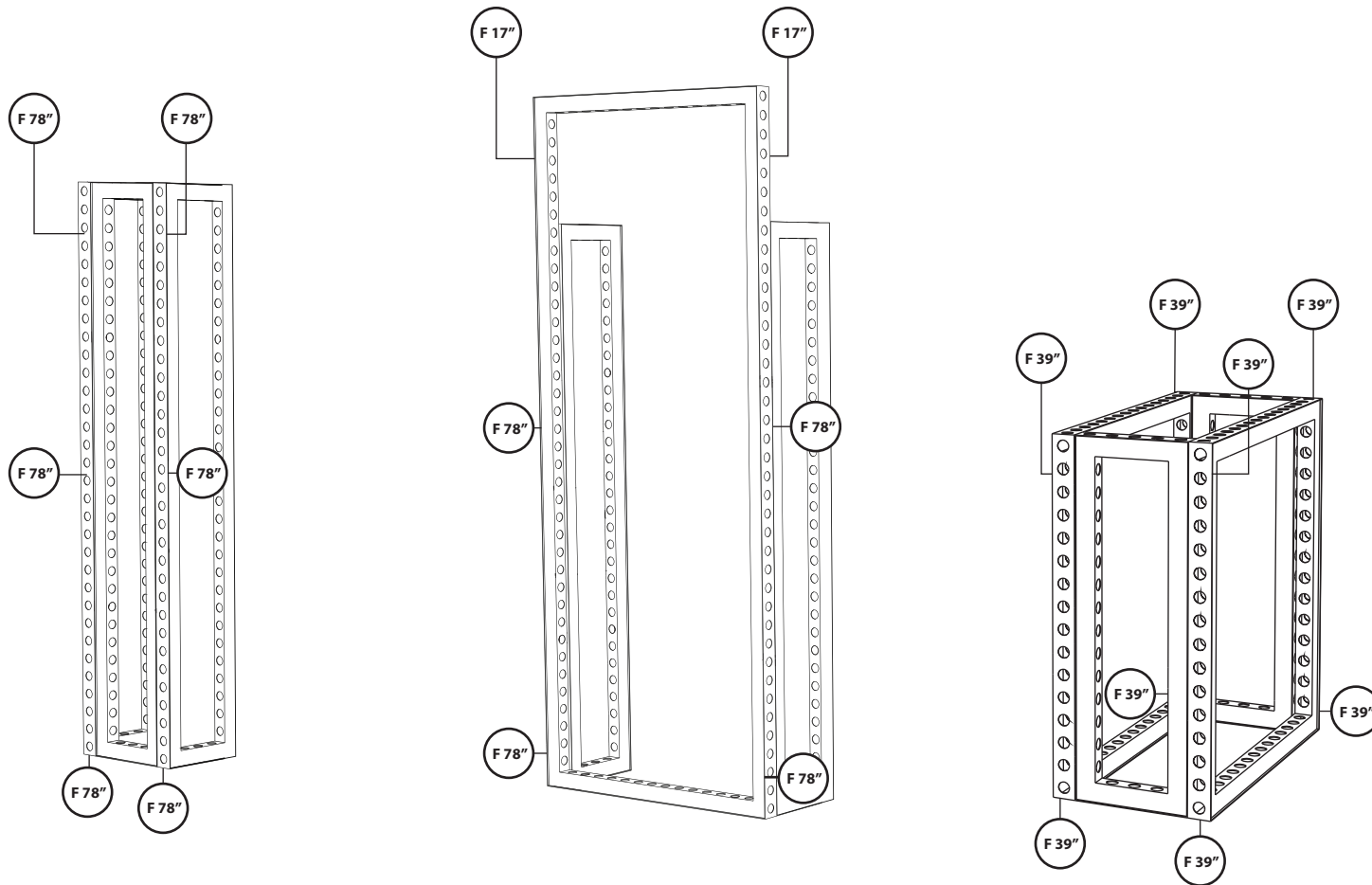

Qty.40 - MOD-CC
Qty.4 - 39" MOD-CP-3100
Qty.4 - 78" MOD-CP-3100
Qty.4 - 95" MOD-CP-3100

**Snap in clip connectors at each designated point and then
reference the measurement and install the cover profile.**
***Overhead view - clip connectors/cover profiles to back side of configuration.**

Graphic Install



Place graphic over the front of the frame.

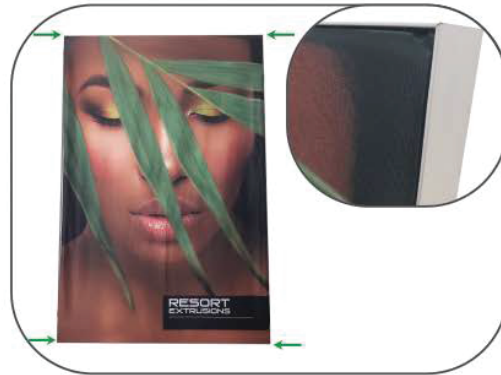

Begin inserting SEG beading at each corner.

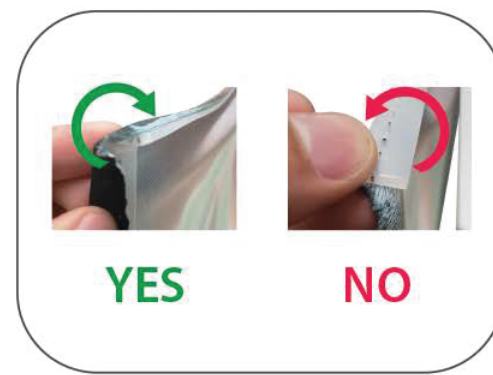

Insert the silicone beading with the fabric folded over. The silicone beading should not be exposed.

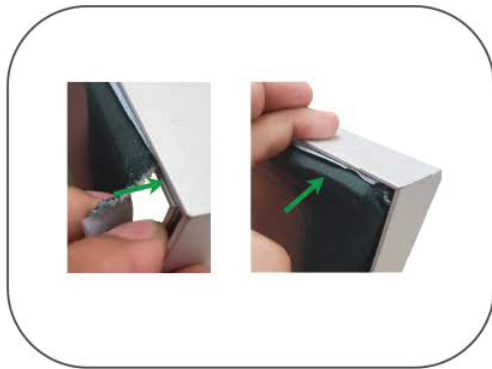

Using your fingers, push both fabric and silicone beading completely into the extrusions channel.

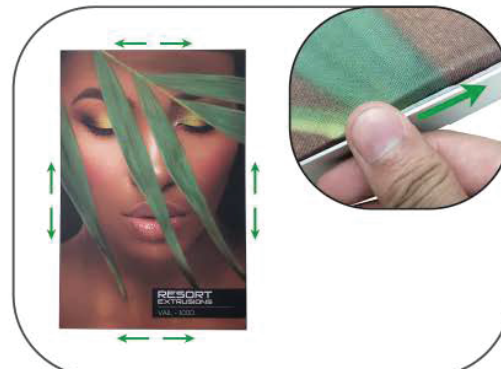

Continue to push in the remaining silicone beading on each side.



Check the perimeter of the frame for any excess beading that hasn't been pushed in. Graphic should be taut.