

SEG'SHOW 3 - 20X10

SEGSHOW MODULAR EXHIBITS

PRODUCT CODE: SEGSHOW3G-20x10G



On frame On graphic



FRONT



BACK

PRODUCT DESCRIPTION

Seg'Show Modular Exhibits 3 - 20x10 is a three-dimensional 20' x 10' pre-designed exhibit booth. Stylish and lively, Modco Modular Exhibits Modular 3 is built using tool-free perforated modular aluminum frames. Multiple size frames connect using simple toolless pin connectors. Use shelves to showcase your products. Customize double-sided stretch fabric SEG graphics for the entire exhibit.

DISPLAY DIMENSIONS	234.3"W x 95"H x 44"D		
GRAPHIC SIZES	PANEL	SIZE	QTY
	A	40.125"W x 96.25"H	4
	B	40.125"W x 79.125"H	6
	C	13.25"W x 79.125"H	20
	D	40.125"W x 40.125"H	4
	E	13.25"W x 40.125"H	2
TOTAL PRINTS			36

GRAPHIC MATERIAL

Dye Sub Fabric

GRAPHIC FINISHING

Silicone beading is sewn around the perimeter of the fabric graphic. Silicone beading is hidden from view once installed.

DISPLAY CONSTRUCTION

Aluminum frame and components

SHIPPING WEIGHTS & DIMENSIONS (FREIGHT ONLY)

Shipping Weight	1415 lbs (frame & graphics in crate)
Shipping Dimensions	103"L x 44"W x 58"H (in crate)

GRAPHIC TURN AROUND TIME

5 business days after proof approval

AVAILABILITY	CA only
--------------	---------

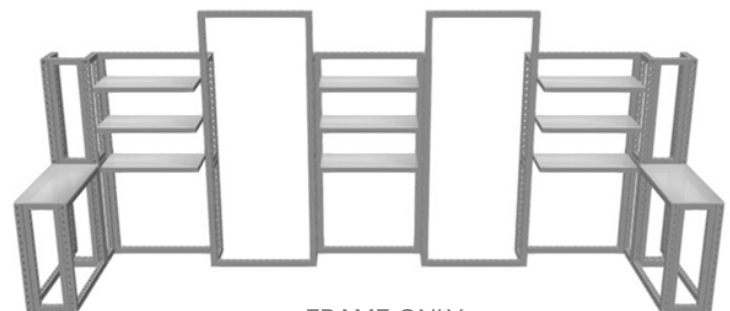
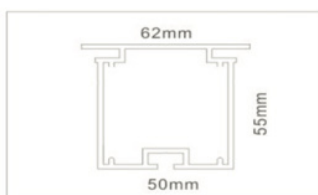
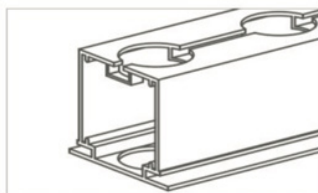

FRAME ONLY

PARTS LIST

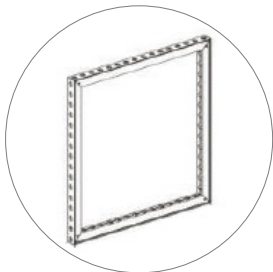

(qty 10)
MOD-FRM-310x1984

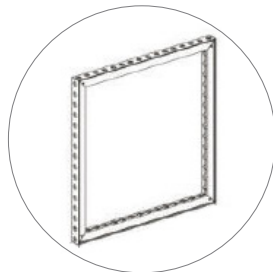

(qty 3)
MOD-FRM-992x1984

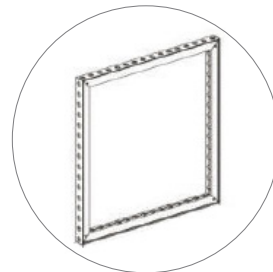

(qty 2)
MOD-FRM-992x2418

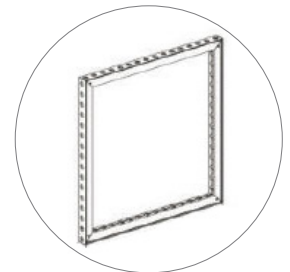

(qty 4)
MOD-FRM-310x992

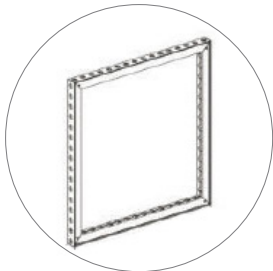

(qty 4)
MOD-FRM-992x992

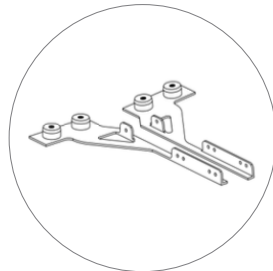

(qty 9)
MOD-SHELF-KIT

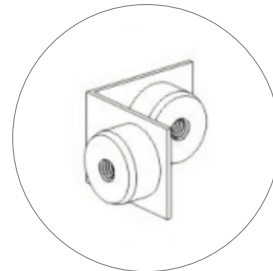

(qty 24)
MOD-90D-CON

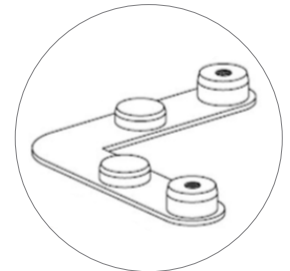

(qty 26)
MOD-SM90D-CON

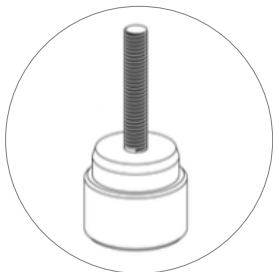

(qty 154)
MOD-PC

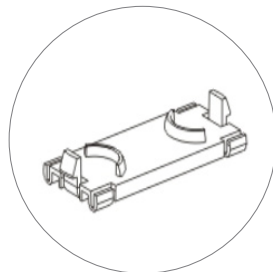

(qty 40)
MOD-CC

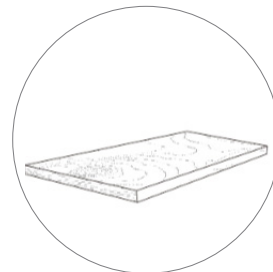

(qty 9)
MOD-PNL (shelf)

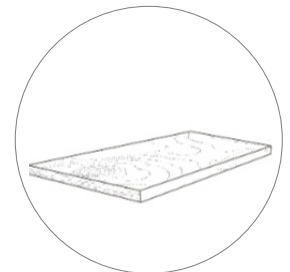

(qty 2)
MOD-PNL (counter)



(qty 8)
78" MOD-CP-3100



(qty 8)
39" MOD-CP-3100



(qty 4)
17" MOD-CP-3100

SET UP INSTRUCTIONS

MODCO-3

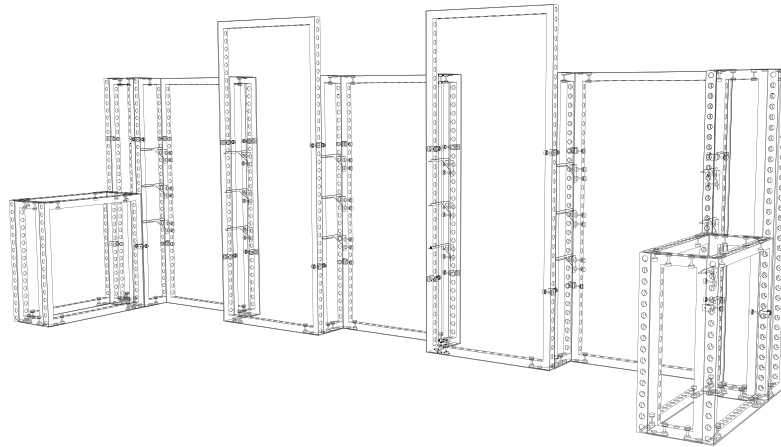

Instructions

Parts / Frames

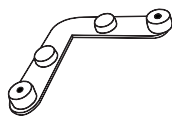

Small 90° Connector
MOD-SM90D-CON
Qty.12



Pin Connector
MOD-PC
Qty.62

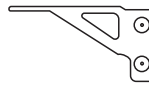

Shelf Kit (left/right)
MOD-SHELF-KIT
Qty.9 (pair)

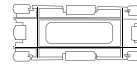

Clip Connector
MOD-CC
Qty.32



90° Connector
MOD-90D-CON
Qty.10

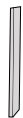

17" Cover Profile
MOD-CP-3100
Qty.4 - 17"



39" Cover Profile
MOD-CP-3100
Qty.8 - 39"



78" Cover Profile
MOD-CP-3100
Qty.8 - 78"

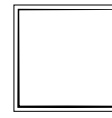

992 x 992
MOD-FRM-992x992
Qty.4



312 x 992
MOD-FRM-312x992
Qty.4



312 x 1984
MOD-FRM-312x1984
Qty.10



992 x 1984
MOD-FRM-992x1984
Qty.3



992 x 1488
MOD-FRM-992x1488
Qty.2



Counter Shelves
MOD-PNL
Qty.9

Connections

C

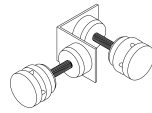

MOD-90D-CON + MOD-PC
Pin Connector heads remain on the inside of frames.

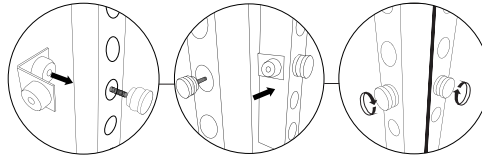

D

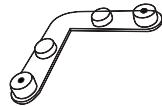

MOD-SM90D-CON / MOD-PC

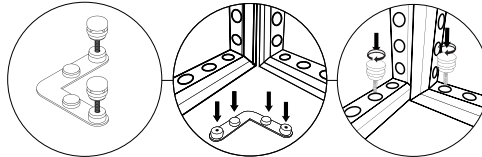

E

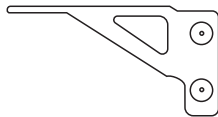

MOD-SHELF-KIT

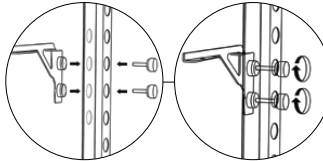

F

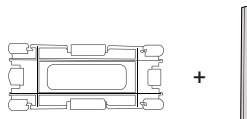

MOD-CC / MOD-CP

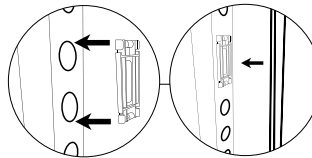

1

A1

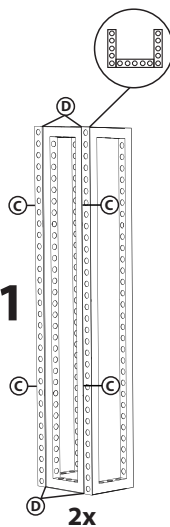

2x

B1

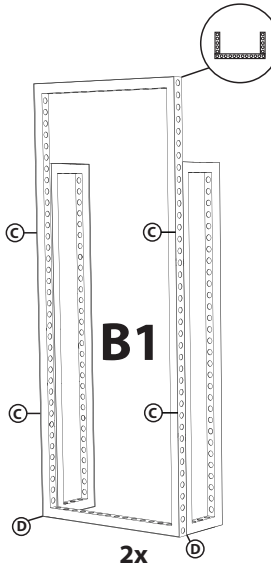

2x

C1

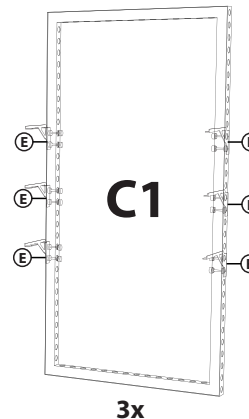

3x

- Qty.10 - MOD-FRM-312x1984
- Qty.2 - MOD-FRM-992x2418
- Qty.3 - MOD-FRM-992x1984
- Qty.12 - MOD-SM90D-CON
- Qty.16 - MOD-90D-CON
- Qty.9 pair - MOD-SHELF-KIT
- Qty.92 - MOD-PC

2

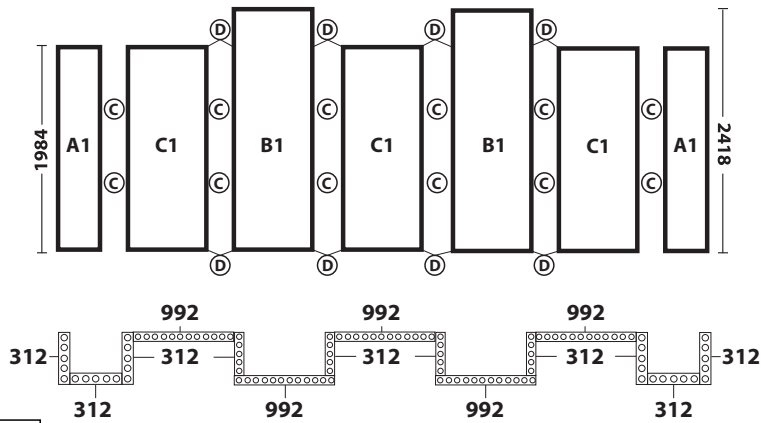
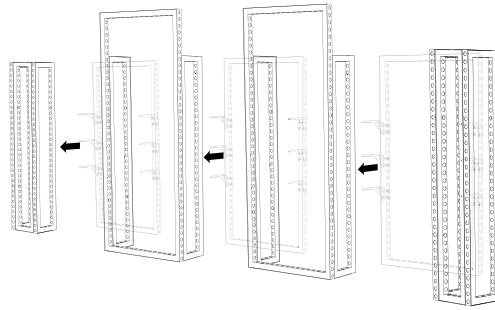

Qty.8 - MOD-SM90D-CON
Qty.12 - MOD-90D-CON
Qty.40 - MOD-PC

3

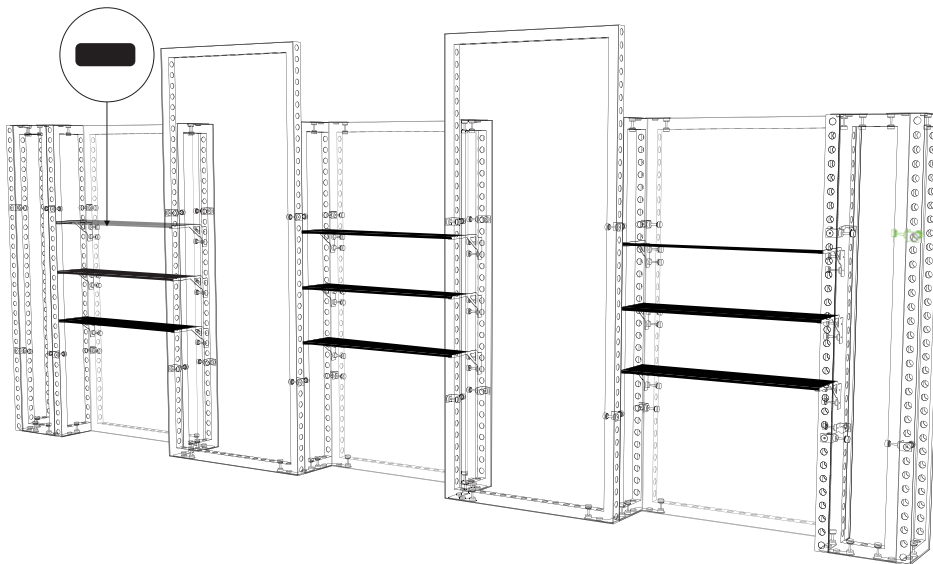

Qty.9 - MOD-PNL

Slide panels onto shelf brackets. NO DRILLING REQUIRED.

4

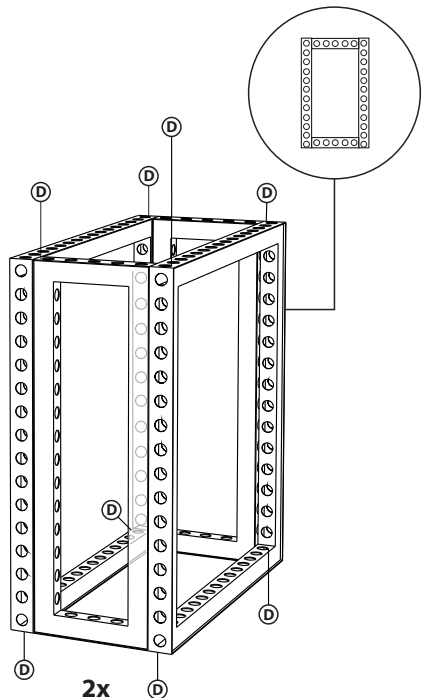

Qty.4 - MOD-FRM-312x992
Qty.4 - MOD-FRM-992x992
Qty.8 - MOD-SM90D-CON
Qty.16 - MOD-PC

5

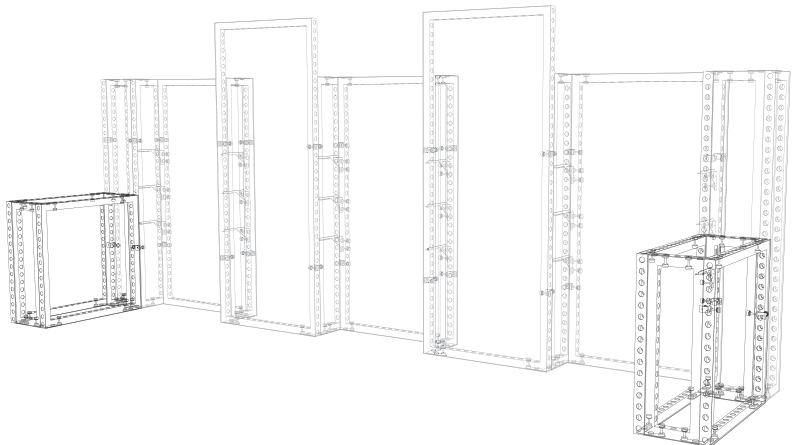

Counters are independent / DOES NOT ATTACH TO BACKWALL BOOTH.

Cover Profiles

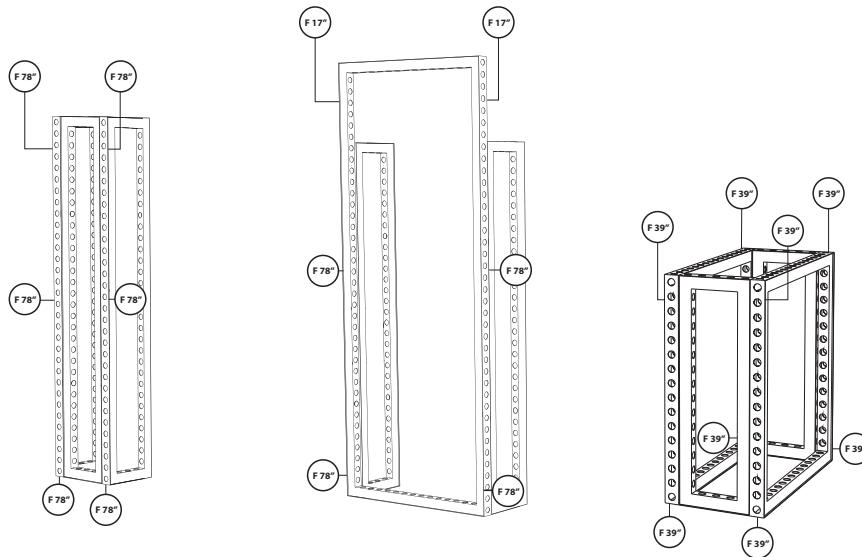

Qty.32 - MOD-CC
 Qty.4 - 39\"/>

Snap in clip connectors at each designated point and then reference the measurement and install the cover profile.

Graphic Install



Place graphic over the front of the frame.



Begin inserting SEG beading at each corner.

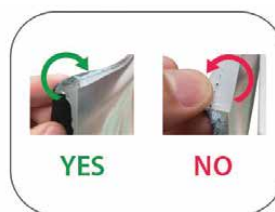

Insert the silicone beading with the fabric folded over. The silicone beading should not be exposed.

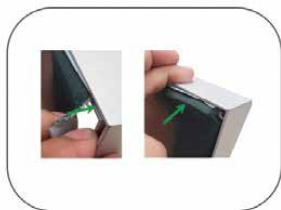

Using your fingers, push both fabric and silicone beading completely into the extrusions channel.



Continue to push in the remaining silicone beading on each side.



Check the perimeter of the frame for any excess beading that hasn't been pushed in. Graphic should be taut.